



LCD TV

LW15M23C
LW17M24C
LW20M21C
LW20M22C

LCD TV

- AFTER SALES SERVICE

- Do not hesitate to contact your retailer or service agent if a change in the performance of your product indicates that a faulty condition may be present.



Owner's Instructions

Before operating the unit,
please read this manual thoroughly,
and retain it for future reference.



BN68-00633F-01

LW15M23C / LW17M24C / LW20M21C / LW20M22C

ON-SCREEN MENUS
PC DISPLAY
TELETEXT

This device is a Class B digital apparatus.

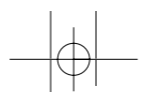



LCD TV

LW15M23C

LW17M24C

LW20M21C

LW20M22C

Owner's Instructions

Before operating the unit,
please read this manual thoroughly,
and retain it for future reference.

ON-SCREEN MENUS
PC DISPLAY
TELETEXT

Do not display a still image (such as on a video game or when hooking up a DVD to this LCD TV) on the Color TFT-LCD (Thin Film Transistor Liquid Crystal Display) panel for a long time as it can cause screen image retention. This image retention is also known as "screen burn". To avoid such image retention, reduce the degree of brightness and contrast of this screen when displaying a still image.

Contents

◆ CONNECTING AND PREPARING YOUR TV	
■ Viewing the Control Panel	4
■ Viewing the Connection Panel	5
– Connecting an Aerial or Cable Television Network	6
– Connecting a Set-Top Box, VCR or DVD	6
– Connecting a Computer	6
– Connecting External A/V Devices	7
– Connecting Headphones	7
– Kensington Slot	7
■ Viewing Pictures From External Sources	8
■ Inserting the Batteries in the Remote Control	9
■ Viewing the Remote Control (All Functions Except Teletext)	10
■ Viewing the Remote Control (Teletext Functions)	11
■ Switching On and Off	12
■ Placing in Standby Mode	12
■ Becoming Familiar with the Remote Control	13
■ Plug & Play	14
■ Selecting TV Mode or an Input Source	16
■ Editing an Input Source Name	17
■ Choosing Your Language	18
◆ SETTING THE CHANNELS	
■ Storing Channels Automatically	19
■ Storing Channels Manually	20
■ Editing the Channels	22
■ Sorting the Stored Channels	23
■ Giving Channels Names	24
◆ SETTING THE PICTURE	
■ Changing the Picture Standard	25
■ Adjusting the Custom Picture	26
■ Adjusting the Screen Background Colour	27
◆ SETTING THE SOUND	
■ Changing the Sound Standard	28
■ Selecting Auto Volume Control	29

Contents

◆ SETTING THE TIME	
■ Setting the Clock	30
■ Switching Off Automatically	31
■ Switching the Television On and Off Automatically	32
◆ USING THE VARIOUS FUNCTIONS	
■ Setting the Blue Screen Mode	33
■ Displaying Information	33
◆ USING THE TELETEXT FEATURE	
■ Teletext Feature	34
■ Displaying the Teletext Information	35
■ Selecting a Page by Number	36
■ Using FLOF to Select a Page	37
■ Storing Teletext Pages	37
◆ USING THE PC FUNCTIONS	
■ Setting Up Your PC Software	38
■ Coarse and Fine Tuning of the Image	39
■ Changing the Image Position	40
■ Initializing the Image Settings	41
■ Adjusting the PC Screen Automatically	42
■ Picture Mode	43
■ Adjusting the Custom Picture	43
■ Adjusting the Screen Background Colour	44
■ Customizing the colour	45
◆ RECOMMENDATIONS FOR USE	
■ Troubleshooting: Before Contacting Service Personnel	46
■ Power Saver	47
■ Technical and Environmental Specifications	48
■ Display Modes	49
■ Cleaning and Maintaining Your TV	50
■ Using the Anti-Theft Kensington Lock	51
■ Installing the Wall Mount Kit	52
■ Installing VESA compliant mounting devices	53

Symbols



Press



Important



Note

Viewing the Control Panel

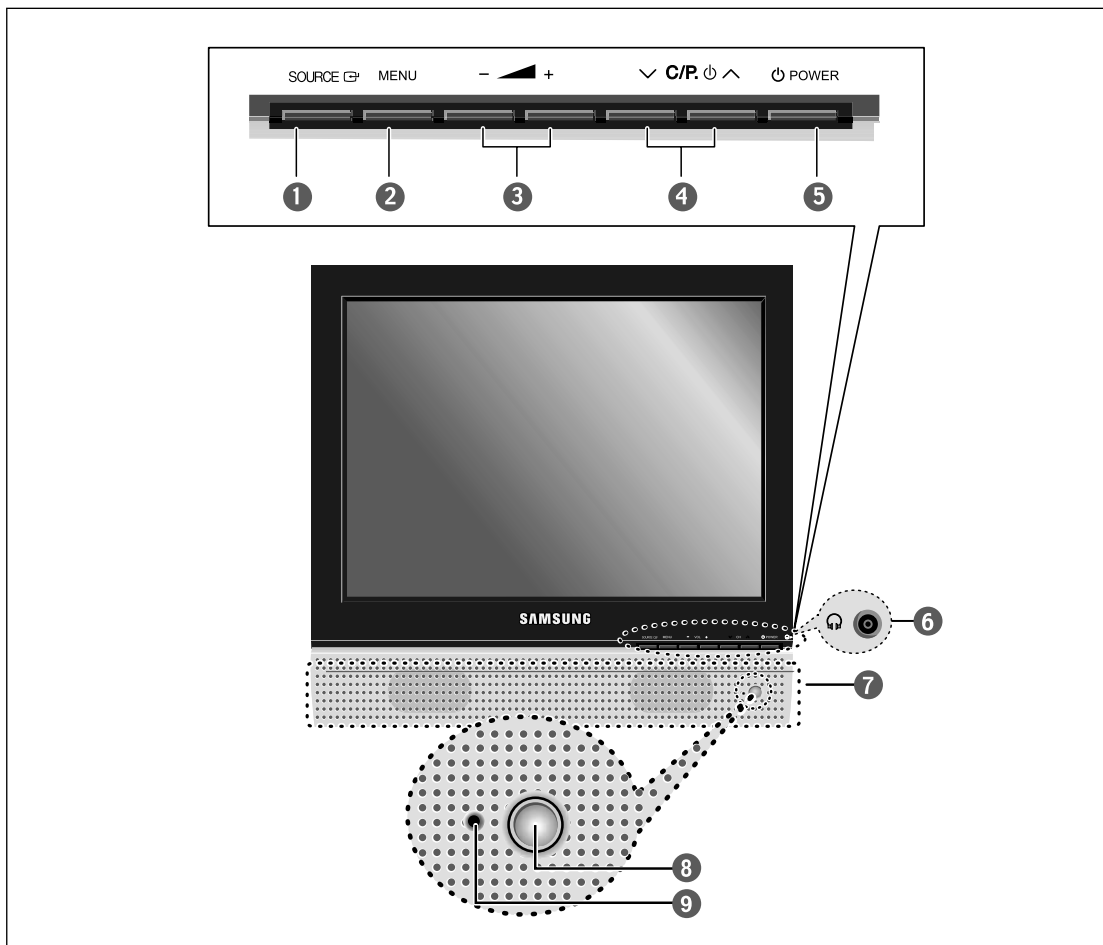

1 SOURCE

Displays a menu of all of the available input sources (TV - AV1 - AV2 - S-Video - PC).

- ▶ You can also use the **SOURCE**() button on the TV's control panel to make selections.

2 MENU

Press to see an on-screen menu of your TV's features.

3 - +

Moves the selector left or right on the OSD.
Decreases or increases the level of audio volume and the values of the selected function.

4 C/P.

Moves the selector down or up on the OSD.
Decreases or increases the channel number.

5 **POWER**

Turns ON/OFF your set.

6 HEADPHONE

7 SPEAKERS

8 REMOTE CONTROL SENSOR

9 POWER INDICATOR

Lights up when you turn the power off.
(Red light shows in stand-by mode, Red shows when you turn the power on, and light is off after the power is on. Green shows when you set Timer on or off.)

Viewing the Connection Panel

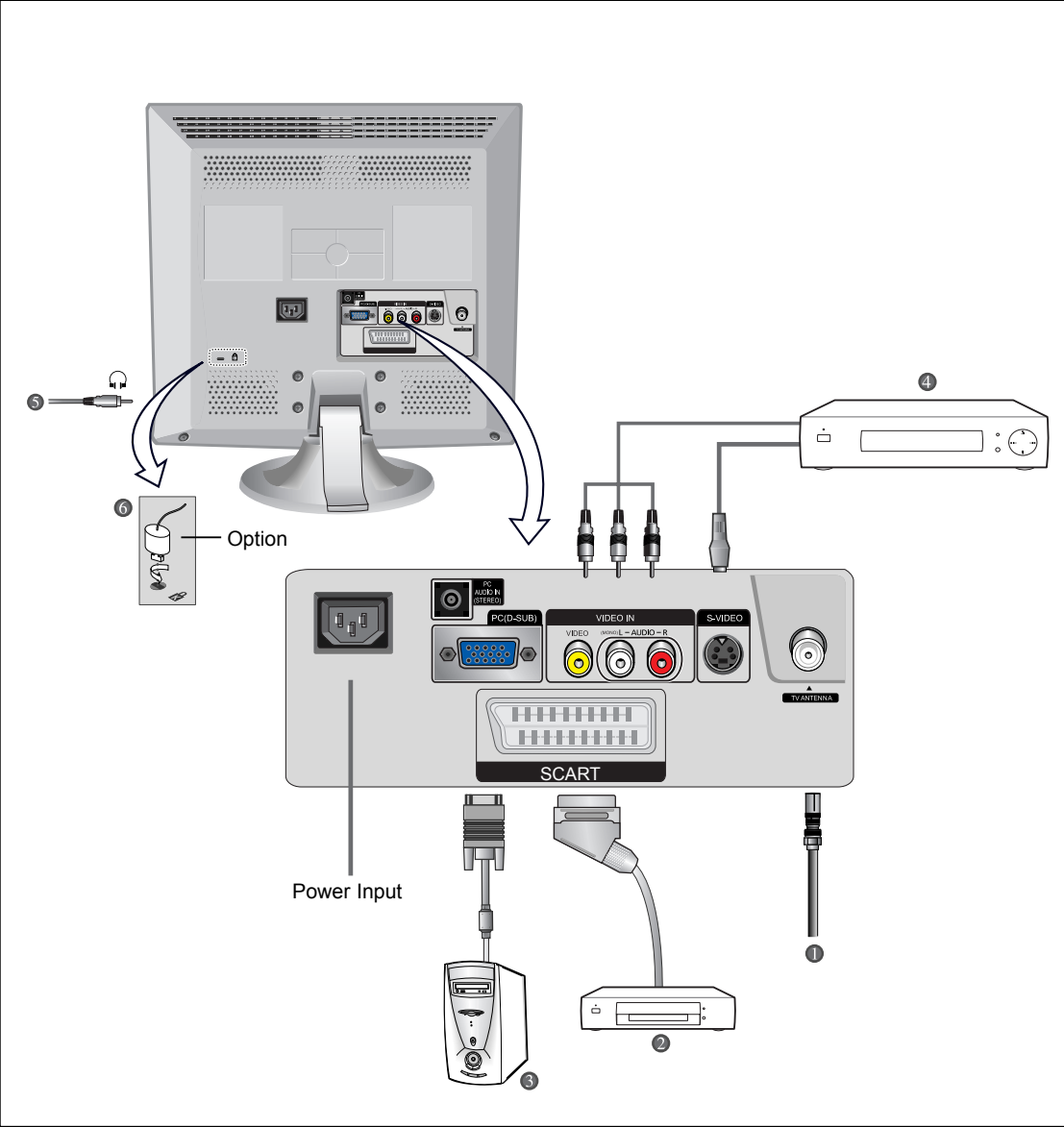

⚠ Whenever you connect an audio or video system to your set, ensure that all elements are switched off. Refer to the documentation supplied with your equipment for detailed connection instructions and associated safety precautions.

Viewing the Connection Panel

❶ Connecting an Aerial or Cable Television Network (depending on the model)

To view television channels correctly, a signal must be received by the set from one of the following sources:

- An outdoor aerial
- A cable television network
- A satellite network

❷ Connecting a Set-Top Box, VCR or DVD

- Connect the VCR, or DVD SCART cable to the SCART connector of the VCR, or DVD.
- If you wish to connect both the Set-Top Box and VCR (or DVD), you should connect the Set-Top Box to the VCR (or DVD) and connect the VCR (or DVD) to your set.

❸ Connecting a Computer

- Connect the 15 Pin D-SUB connector to the PC video connector.
- Connect the stereo audio cable to the "Audio (ST)" jack on the rear of your set and the other end to the "Audio Out" jack of the sound card on your computer.

➤ 15 Pin D-SUB connector

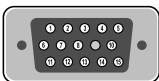

Pin	Separate H/V	Composite H/V
1	Red (R)	Red (R)
2	Green (G)	Green (G)
3	Blue (B)	Blue (B)
4	Grounding	Grounding
5	Grounding (DDC return)	Grounding (DDC return)
6	Grounding - Red (R)	Grounding - Red (R)
7	Grounding - Green (G)	Grounding - Green (G)
8	Grounding - Blue (B)	Grounding - Blue (B)
9	No connection	No connection
10	Grounding - Sync. / Self test	Grounding - Sync. / Self test
11	Grounding	Grounding
12	DDC - SDA (Data)	DDC - SDA (Data)
13	Horizontal Sync.	Horizontal/Vertical Sync.
14	Vertical Sync.	Not used
15	DDC - SCL (Clock)	DDC - SCL (Clock)

Viewing the Connection Panel

4 Connecting External A/V Devices

- Connect RCA or S-VIDEO cables to an appropriate external A/V device such as a VCR, DVD or Camcorder.
- Connect RCA audio cables to "(MONO)L-AUDIO-R" on the rear of your set and the other ends to corresponding audio out connectors on the A/V device.

5 Connecting Headphones

- Plug a set of headphones into the 3.5mm mini-jack socket on the right-side of the set.
- Headphones may be connected to the headphone output on the right-side of the set.
While the headphones are connected, the sound from the built-in speakers will be disabled.

6 Kensington Slot

- This television has been designed to apply a burglarproof lock.(See page 51)

➤ Retractable Stand

Note: The maximum tilt angle is 13 degrees in the backward direction.

Please do not tilt the TV outside the specified range. Using excessive force to tilt the TV may cause permanent damage to the mechanical part of the stand.

< LW20M21C / LW20M22C > model swivels left and right.



< LW15M23C / LW17M24C >



< LW20M21C / LW20M22C >

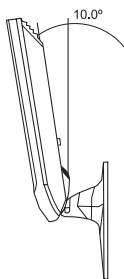
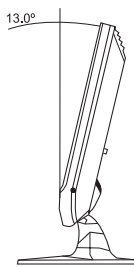

Viewing Pictures From External Sources



Once you have connected up your various audio and video systems, you can view the different sources by selecting the appropriate input.

- 1 Check that all the necessary connections have been made (refer to pages **6** and **7** for further details).
- 2
 - ◆ Press the **TV** button to choose TV mode.
 - ◆ Press the **SOURCE** button to choose Video mode.
The input sources are displayed in the following order:
AV1 - AV2 - S-Video - PC.

Inserting the Batteries in the Remote Control

You must insert or replace the batteries in the remote control when you:

- ◆ *Purchase your set*
- ◆ *Find that the remote control is no longer operating correctly*

- 1 Remove the cover on the rear of the remote control by pressing the symbol downwards and then pulling firmly to remove it.
- 2 Install two **AAA** size batteries.
 - ◆ + on the battery against + on the remote control
 - ◆ - on the battery against - on the remote control
- 3 Replace the cover by aligning it with the base of the remote control and pressing it back into place.

➤ Do not mix battery types, i.e. alkaline and manganese.

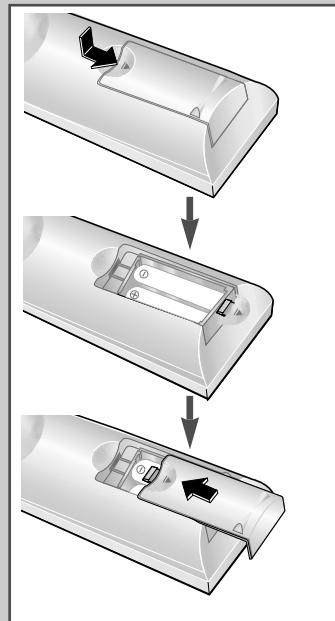

Viewing the Remote Control (All Functions Except Teletext)

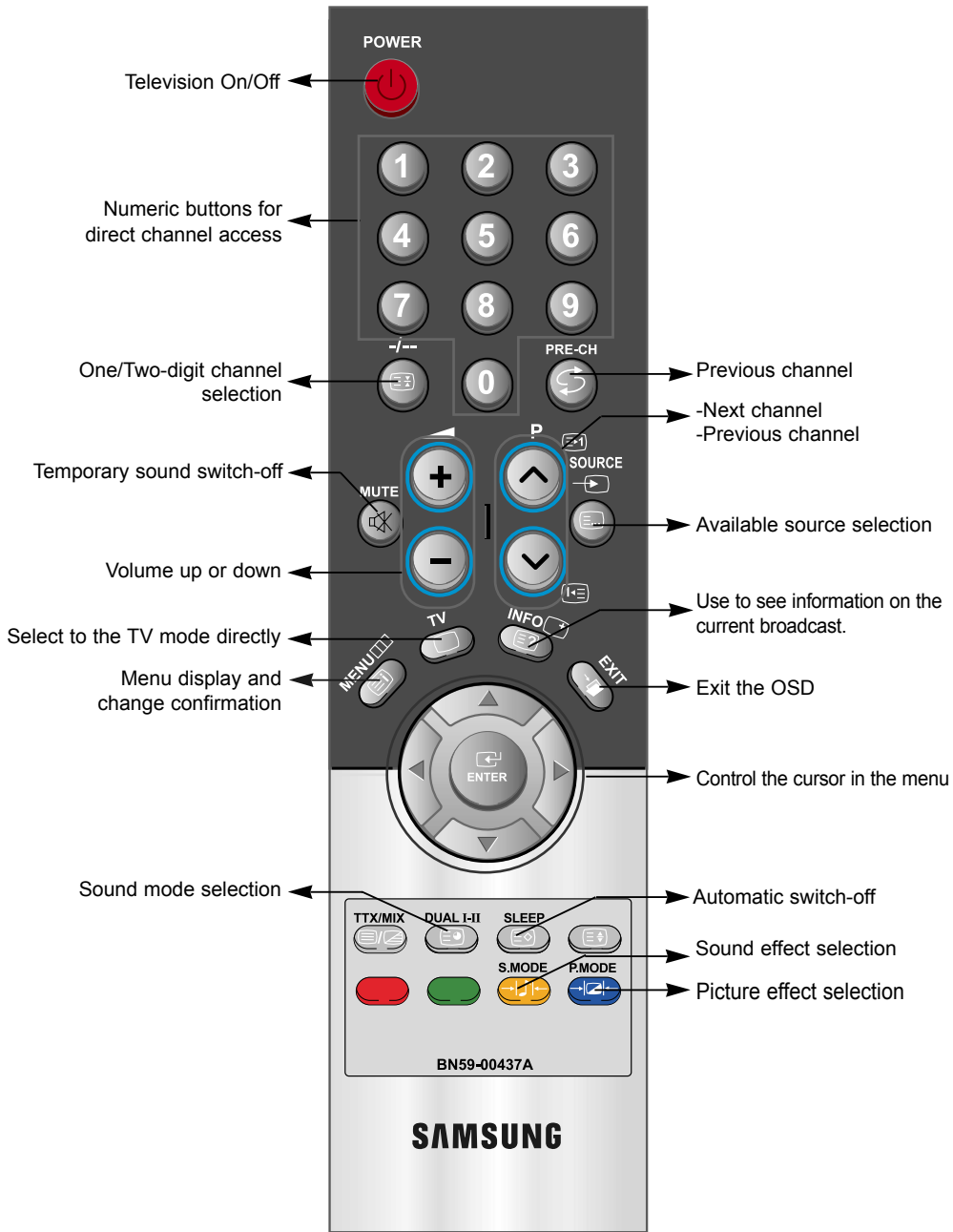

➤ The performance of the remote control may be affected by bright light.

Viewing the Remote Control (Teletext Functions)

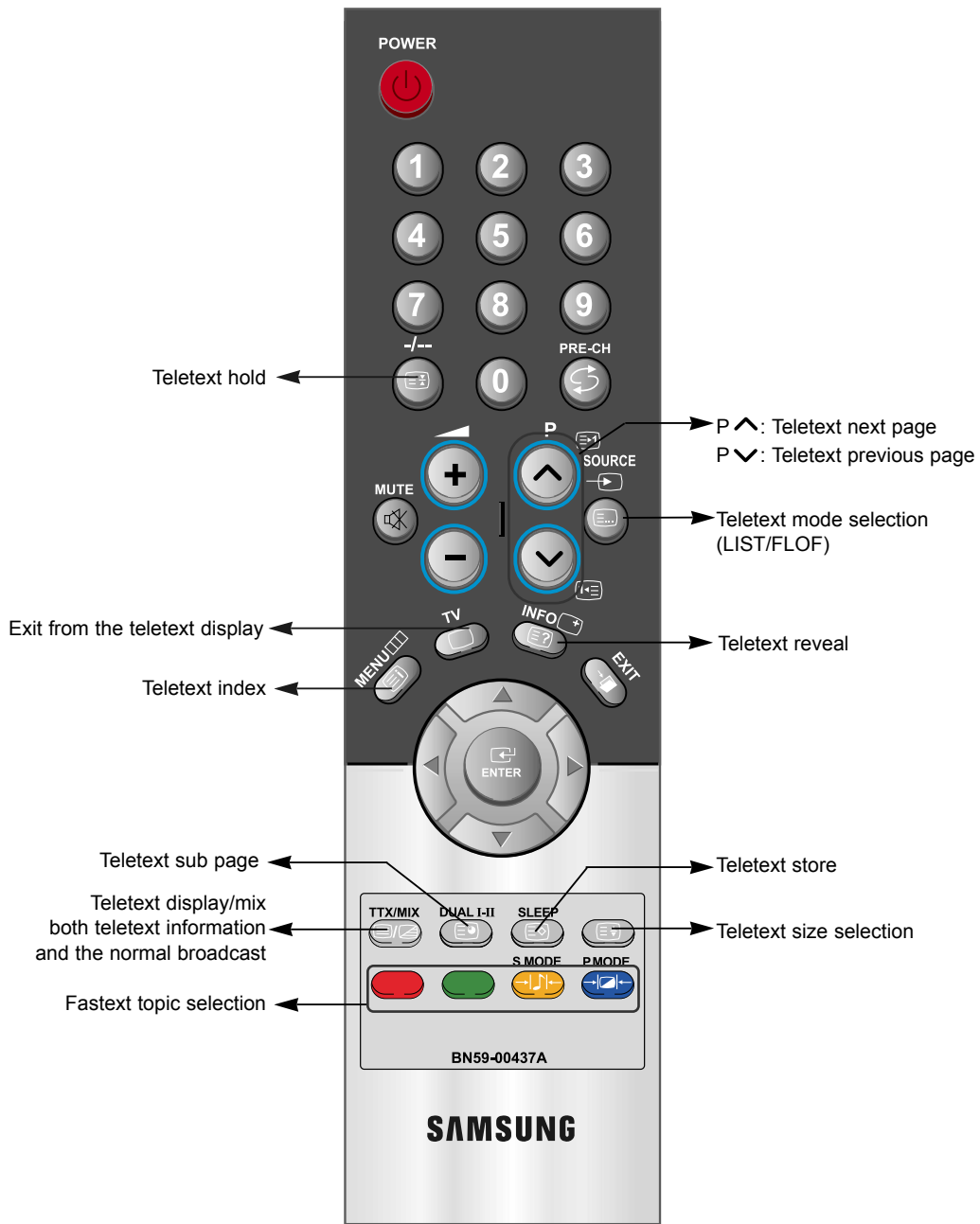

Switching On and Off

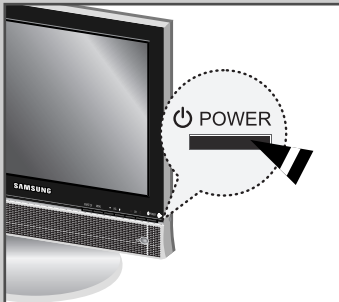
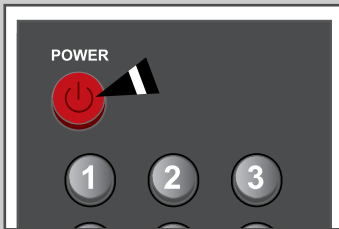

The mains lead is attached to the rear of your set.

- 1 Plug the mains lead into an appropriate socket.
Result: When the power cord is plugged in, the LED turns red.
- 2 Press the **POWER** button to switch on.
- 3 To switch off, press the **POWER** button again.

Placing in Standby Mode

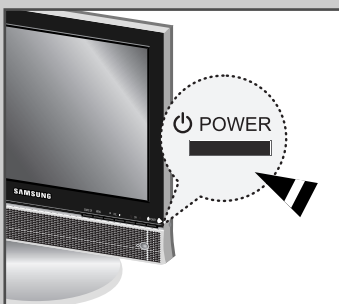

Your set can be placed in Standby mode in order to reduce the power consumption.

The Standby mode can be useful when you wish to interrupt viewing temporarily (during a meal, for example).















- 1 Press the **POWER** button.
 - 2 To switch back on, simply press the **POWER** button again, a numeric button, or channel ∇ or \blacktriangle button.
- Do not leave your set in Standby mode for long periods of time (when you are away on holiday, for example). Turn off by pressing the **POWER** button. It is best to unplug the set from the mains and aerial.

Becoming Familiar with the Remote Control

The remote control is used mainly to:

- ◆ Change channels and adjust the volume
- ◆ Set up your set using the on-screen menu system

The following table presents the most frequently used buttons and their functions.

Button	Viewing Function	Menu Function
 P	Used to display the next stored channel.	-
 P	Used to display the previous stored channel.	-
 PRE-CH	Used to switch repeatedly between the last two channels displayed. (PRE-CH ; Previous Channel)	
 1 - 9	Used to display the corresponding channels.	
 -/--	Used to select a channel numbered ten or over. Press this button, and the "--" symbol is displayed. Enter the two-digit channel number.	
 +	Used to increase the volume.	-
 -	Used to decrease the volume.	-
 MUTE	Used to switch the sound off temporarily.  To turn the sound back on, press this button again, or press the + or - button.	
 MENU	Used to display the on-screen menu system.	Used to return to the previous menu or normal viewing.
 EXIT	Used to exit the menu system and return directly to normal viewing.	
	▲▼ Used to move among the menu items.	
	Used to select a menu item or increase the value of the selected item.	
	Used to return to the previous menu item or decrease the value of the selected item.	



Plug & Play

Plug & Play

Plug & Play

Language

English

Français

Italiano

Deutsch

Español

Nederlands

◀ Move

⏏ Enter

⏏ Skip

Plug & Play

Check antenna input.

OK

⏏ Enter

⏏ Skip

Plug & Play

Country

Switzerland

Sweden

United Kingdom

Eastern Europe

Others

◀ Move

⏏ Enter

⏏ Skip

Plug & Play

Auto Store

P 1 C 4 --

40 MHz

0 %

Start

⏏ Enter

⏏ Skip

Plug & Play

Hour

Minute

Clock Set

--

--

⏏ Enter

⏏ Skip

Plug & Play

Hour

Minute

Clock Set

00

00

◀ Move

⬆ Adjust

⏏ Enter

Enjoy your viewing

English-14

When the set is initially powered ON, you are automatically presented with a series of basic customer settings. The following settings are available.

- 1 If the set is in standby mode, press the **POWER** button on the remote control.
Result: The message **Plug & Play** is displayed. It appears for a little while, and then the **Language** menu is automatically displayed.
- 2 Select the appropriate **Language** by pressing the **▲** or **▼** button.
➤ The available languages are listed. You can choose one of 12 languages.
- 3 Press the **ENTER** **⏏** button to confirm your choice.
Result: The message **"Check antenna input."** is displayed with **OK** selected.
- 4 Press the **ENTER** **⏏** button.
Result: The country menu is displayed:
Belgium - Germany - Spain - France - Italy - Netherlands - Switzerland - Sweden - United Kingdom - Eastern Europe - Others
- 5 Select your **Country** by pressing the **▲** or **▼** button. Press the **ENTER** **⏏** button.
Result: The **Auto Store** menu is displayed.
- 6 Press the **ENTER** **⏏** button.
Result: The channel search will start and end automatically.
- 7 Select the **Hour** or **Minute** by pressing the **◀** or **▶** button. Set the **Hour** or **Minute** by pressing the **▲** or **▼** button. (Refer to **"Setting the Clock"** on page 30)
- 8 Press the **MENU** button to confirm your setting.
Result: The message **"Enjoy your viewing"** is displayed, and then the channel which has been stored will be activated.
- 9 Press the **EXIT** button to exit.

Plug & Play

If you want to reset this feature...

- 1 Press the **MENU** button.

Result: The main menu is displayed.

- 2 Press the **▲** or **▼** button to select the **Setup**.

Result: The options available in the **Setup** group are displayed.

- 3 Press the **ENTER**  button.

- 4 Press the **▲** or **▼** button to select the **Plug & Play**.

Press the **ENTER**  button.

Result: The message **Plug & Play** is displayed.

- 5 For further details on how to set up this feature, refer to the previous page.

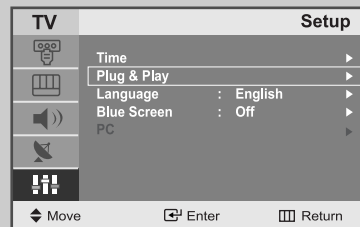
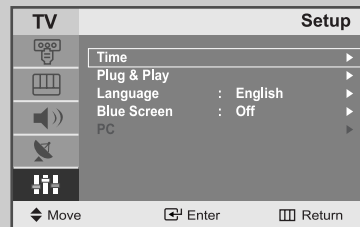

Selecting TV Mode or an Input Source

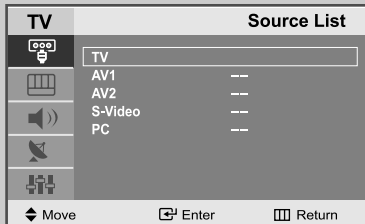
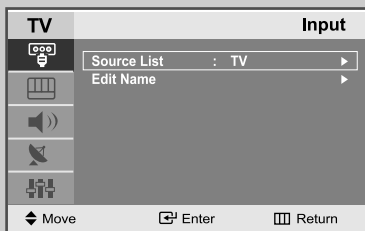

You can choose TV mode or change to an input source connected to the TV set. Use this button to choose an input source that you would like to watch.

- 1 Press the **MENU** button.

Result: The main menu is displayed.

- 2 Press the **ENTER** button to select the **Input**.

Result: The options available in the **Input** group are displayed.

- 3 Press the **ENTER** button.

Result: The **Source List** is selected.

- 4 Press the **▲** or **▼** button to move to the input source that you wish to choose.
Press the **ENTER** button.

Result: The input source changes to the one you have chosen.

Editing an Input Source Name

Entering the names of the input source devices connected to the input ports on the TV set allows you to find and choose an input source that you would like to watch in a quick and convenient manner.

- 1 Press the **MENU** button.

Result: The main menu is displayed.

- 2 Press the **ENTER** button to select the **Input**.

Result: The options available in the **Input** group are displayed.

- 3 Press the **▲** or **▼** button to select the **Edit Name**.

Press the **ENTER** button.

- 4 Press the **▲** or **▼** button to move to the input source that you wish to edit.

Press the **ENTER** button.

Result: The following options are available:

- 5 Select the required device by pressing the **▲** or **▼** repeatedly.

Result: The following options are available:

---- - **VCR** - **DVD** - **Cable STB** - **HD STB** - **Satellite STB** -
AV Receiver - **DVD Receiver** - **Game** - **Camcorder** - **DVD**
Combo - **DHR** - **PC**.

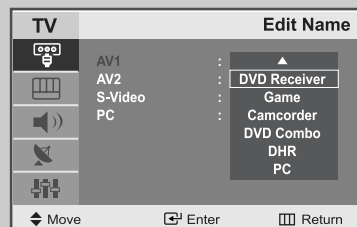
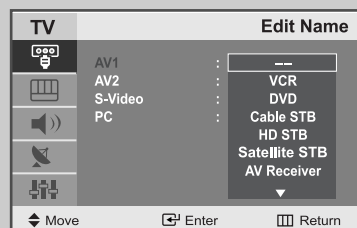
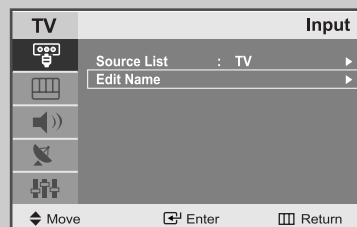

- 6 When you are satisfied with your choice, press the **EXIT** button to return to normal viewing.

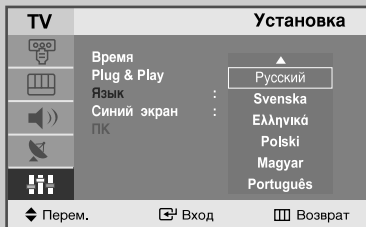
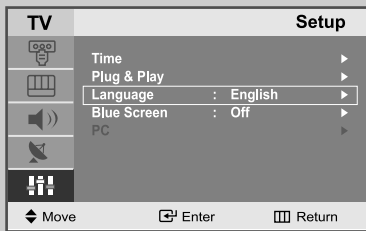
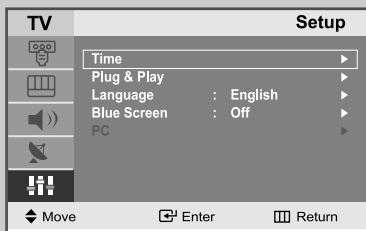

Choosing Your Language



When you start using your set for the first time, you must select the language which will be used for displaying menus and indicators.

- 1 Press the **MENU** button.
Result: The main menu is displayed.
- 2 Press the **▲** or **▼** button to select the **Setup**.
Result: The options available in the **Setup** group are displayed.
- 3 Press the **ENTER**  button.
- 4 Press the **▲** or **▼** button to select the **Language**.
Press the **ENTER**  button.
- 5 Select a particular **Language** by pressing the **▲** or **▼** button repeatedly.
- 6 When you are satisfied with your choice, press the **EXIT** button to return to normal viewing.

Storing Channels Automatically

You can scan for the frequency ranges available to you (and availability depends on your country). Automatically allocated programme numbers may not correspond to actual or desired programme numbers. However you can sort numbers manually and clear any channels you do not wish to watch.

- 1 Press the **MENU** button.

Result: The main menu is displayed.

- 2 Press the **▲** or **▼** button to select the **Channel**.

Result: The options available in the **Channel** group are displayed.

- 3 Press the **ENTER**  button.

- 4 Press the **▲** or **▼** button to select **Auto Store**.
Press the **ENTER**  button.

Result: The **Start** is selected.

- 5 Press the **ENTER**  button to search the channels.
The sub menu is changed from **Start** to **Stop** with channel search started.

Result: The search will end automatically.

Channels are sorted and stored in an order which reflects their position in the frequency range, (with lowest first and highest last). The programme originally selected is then displayed.

- To stop the search before it has finished, press the **ENTER**  button to search the channels.

- 6 When the channels have been stored, you can:

- ◆ Add or delete the channels (refer to page 22)
- ◆ Sort them in the order required (refer to page 23)
- ◆ Assign a name to the stored channels (refer to page 24)

- 7 Press the **EXIT** button to exit.

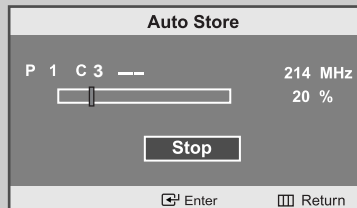
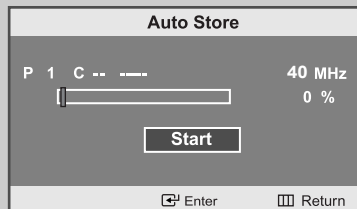
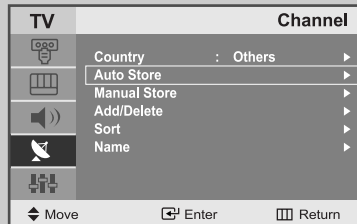

Storing Channels Manually

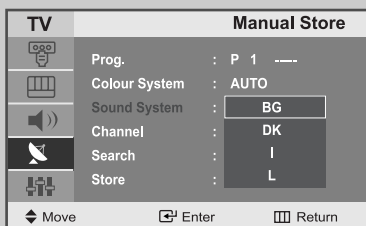
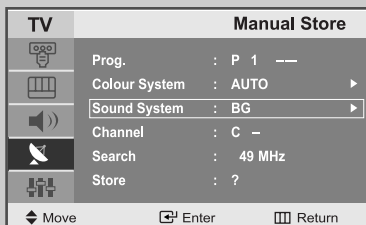
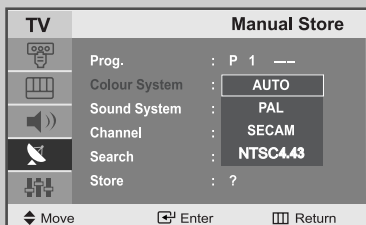
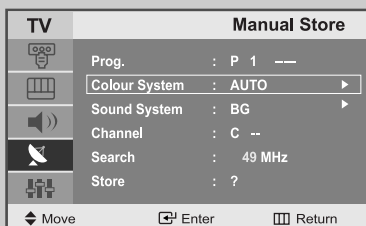
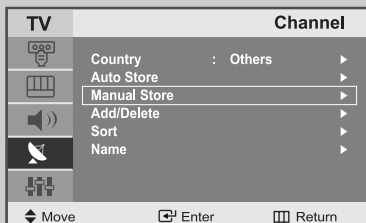

You can store up to 100 channels, including those received via cable networks.

When storing channels manually, you can choose:

- ◆ Whether or not to store each of the channels found
- ◆ The programme number of each stored channel which you wish to identify

1 Press the **MENU** button.

Result: The main menu is displayed.

2 Press the **▲** or **▼** button to select the **Channel**.

Result: The options available in the **Channel** group are displayed.

3 Press the **ENTER** button.

4 Press the **▲** or **▼** button to select the **Manual Store**.
Press the **ENTER** button.

Result: The options available in the **Manual Store** group are displayed with the **Prog.** selected.

5 Press the **▲** or **▼** button to select **Colour System**.
Press the **ENTER** button.

Select the **Colour System** required by pressing the **▲** or **▼** button repeatedly and then press the **ENTER** button.

Result: The colour standards are displayed in the following order:
AUTO - PAL - SECAM - NTSC4.43

6 Press the **▲** or **▼** button to select **Sound System**.
Press the **ENTER** button.

Select the **Sound System** required by pressing the **▲** or **▼** button repeatedly and then press the **ENTER** button.

Result: The sound standards are displayed in the following order:
BG - DK - I - L

7 For all the channels to move to the required channel numbers, repeat steps 5 to 6 after selecting **Prog.** by pressing the **▲** or **▼** button.

Storing Channels Manually

- 8** If you know the channel number to be stored,
- ◆ Press the ▲ or ▼ button to select the **Channel**.
Press the **ENTER** button.
 - ◆ Select **C** (Air channel) or **S** (Cable channel) by pressing the ▲ or ▼ button and then press the **ENTER** button.
 - ◆ Select the required number by pressing the ▲ or ▼ button and then press the **ENTER** button.
- If there is normal sound or no sound, re-select the sound system required.
-
- 9** If you do not know the channel numbers, press the ▲ or ▼ button to select **Search**.
Press the **ENTER** button.
Start the **Search** by pressing the ▲ or ▼ button.
Press the **ENTER** button.
- Result: The tuner scans the frequency range until the first channel or the channel that you selected is received on your screen.
-
- 10** Press the ▲ or ▼ button to select **Store**.
Press the **ENTER** button.
The **OK** is selected.
- Result: The channel and associated programme number are stored.
-
- 11** Repeat Steps **8** to **10** for each channel to be stored.
-
- 12** Press the **EXIT** button to exit.

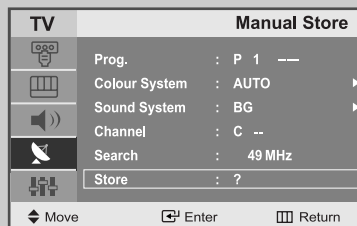
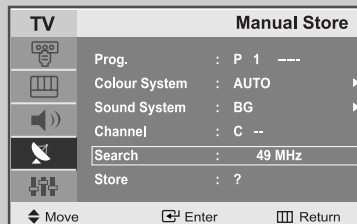
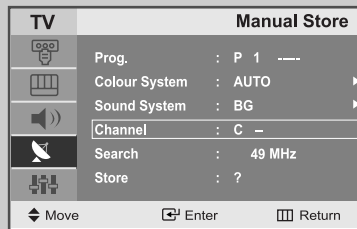

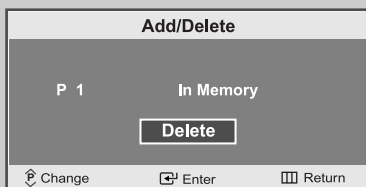
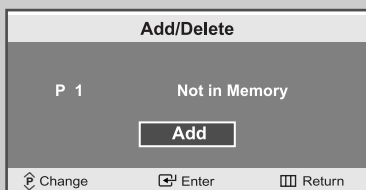
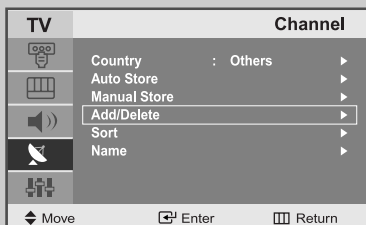

Editing the Channels



You can exclude any channels of your choice from the channels you have scanned. When you scan through the stored channels, those you have chosen to skip are not displayed.





All channels that you do not specifically choose to skip are displayed during scanning.

- 1 Press the **MENU** button.
Result: The main menu is displayed.
- 2 Press the **▲** or **▼** button to select the **Channel**.
Result: The options available in the **Channel** group are displayed.
- 3 Press the **ENTER**  button.
- 4 Press the **▲** or **▼** button to select **Add/Delete**.
Press the **ENTER**  button.
Result: The state of the current channel is displayed.
- 5 Press the **^** or **v** button to select the channel that you wish to **Add** or **Delete**.
Result: If the channel that you wish to edit is not in memory, Add is selected and displayed.
Otherwise, if the channel that you wish to edit is in memory, Delete is selected and displayed.
- 6 Press the **ENTER**  button to **Add** or **Delete** the channel.
- 7 Repeat Step 5 for each channel to be added or erased.
- 8 Press the **EXIT** button to exit.

Sorting the Stored Channels

You can exchange the numbers of two channels, in order to:

- ◆ **Modify the numeric order in which the channels have been automatically stored.**
- ◆ **Assign easily remembered numbers to the channels that you watch most often.**

- 1 Press the **MENU** button.
Result: The main menu is displayed.
- 2 Press the **▲** or **▼** button to select the **Channel**.
Result: The options available in the **Channel** group are displayed.
- 3 Press the **ENTER**  button.
- 4 Press the **▲** or **▼** button to select **Sort**.
Press the **ENTER**  button.
Result: The current **Prog.**, **Channel** and **Name** are displayed.
- 5 Select the channel number that you wish to change by pressing the **▲** or **▼** button repeatedly.
Press the **ENTER**  button.
Result: The selected **Channel** and **Name** are moved to the right side.
- 6 Press the **▲** or **▼** button to move to the position which you would like to change and then press the **ENTER**  button.
Result: The selected channel is exchanged with the one previously stored to the chosen number.
- 7 Repeat step 5 to 6 for another channel to sort again.
- 8 Press the **EXIT** button to exit.

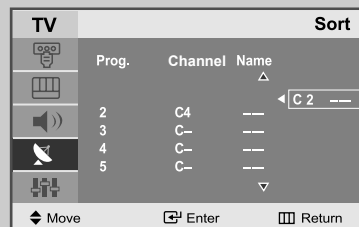
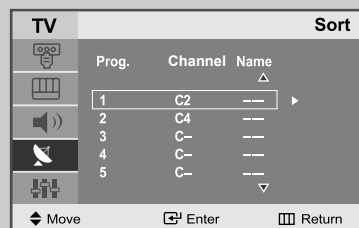

Giving Channels Names

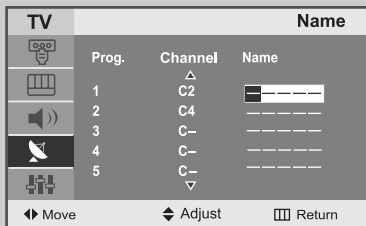
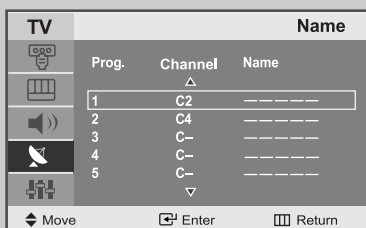
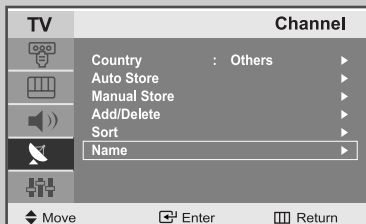



If channel name information is broadcast when you store the channels either manually or automatically, the names are assigned to the channels directly. You can however change these names or assign new names as required.

- Press the **MENU** button.
Result: The main menu is displayed.
 - Press the **▲** or **▼** button to select the **Channel**.
Result: The options available in the **Channel** group are displayed.
 - Press the **ENTER** button.
 - Press the **▲** or **▼** button to select the **Name**.
Press the **ENTER** button.
Result: The current **Program**, **Channel** and **Name** are displayed.
 - If necessary, select the channel to be assigned to a new **Name** by pressing the **▲** or **▼** button.
Press the **ENTER** button.
Result: The selection bar is displayed around the name box.
- | 6 | To... | Then... |
|---|-----------------------------------|---------------------------------------|
| | Select a letter, number or symbol | Press the ▲ or ▼ button |
| | Move on to the next letter | Press the ▶ button |
| | Move back to the previous letter | Press the ◀ button |
| | Confirm the name | Press the ENTER button |
- The characters available are :
- ◆ Letters of the alphabet (A~Z)
 - ◆ Numbers (0~9)
 - ◆ Special characters (space, _)
- Repeat Steps **5** to **6** for each channel to be assigned to a new name.
 - When you have finished entering the name, press the **ENTER** button to confirm the name.

Changing the Picture Standard

You can select the type of picture which best corresponds to your viewing requirements.

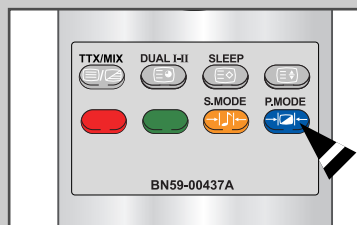
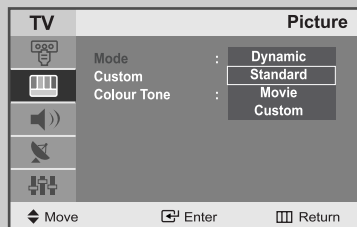
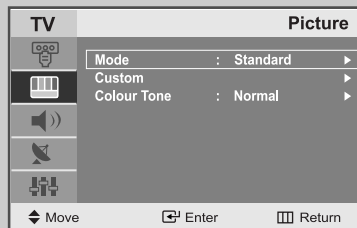

- 1 Press the **MENU** button.
Result: The main menu is displayed.
 - 2 Press the **▲** or **▼** button to select the **Picture**.
Result: The options available in the **Picture** group are displayed.
 - 3 Press the **ENTER**  button.
 - 4 Press the **ENTER**  button.
Result: The **Mode** is selected.
 - 5 Select the required picture effect by pressing the **▲** or **▼** button repeatedly.
Press the **ENTER**  button.
Result: The following picture effects are available:
Dynamic - Standard - Movie - Custom
 - 6 Press the **EXIT** button to exit.
- You can also set these options simply by pressing the **P.MODE** (Picture Mode) button.

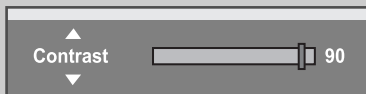
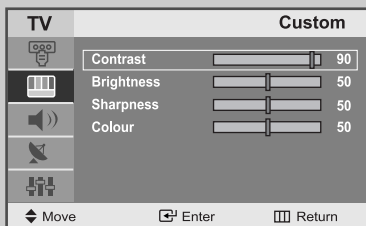
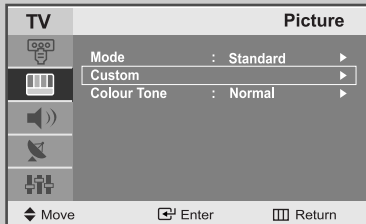
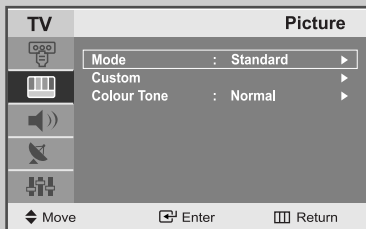

Adjusting the Custom Picture



Your set has several settings which allow you to control picture quality.

- 1 Press the **MENU** button.
Result: The main menu is displayed.
- 2 Press the **▲** or **▼** button to select the **Picture**.
Result: The options available in the **Picture** group are displayed.
- 3 Press the **ENTER**  button.
- 4 Press the **▲** or **▼** button to select the **Custom**.
Press the **ENTER**  button.
- 5 Select the option (**Contrast, Brightness, Sharpness, Colour or Tint-NTSC only**) to be adjusted by pressing the **▲** or **▼** button.
Press the **ENTER**  button.
Result: The horizontal bar is displayed.
- 6 Press the **◀** or **▶** button to reach the required setting.
- 7 When you are satisfied with the setting, press the **MENU** button to return to the previous menu or press the **EXIT** button to return to normal viewing.

➤ If you make any changes to these settings, the picture standard is automatically switched to **Custom**.

Adjusting the Screen Background Colour

You can change the screen background colour according to your preference.

- 1 Press the **MENU** button.
Result: The main menu is displayed.

- 2 Press the **▲** or **▼** button to select the **Picture**.
Result: The options available in the **Picture** group are displayed.

- 3 Press the **ENTER**  button.

- 4 Press the **▲** or **▼** button to select the **Colour Tone**.
Press the **ENTER**  button.
Result: The following options are available:
Cool 2 - Cool 1 - Normal - Warm 1 - Warm 2

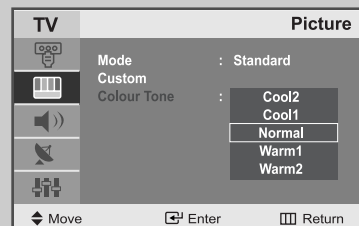
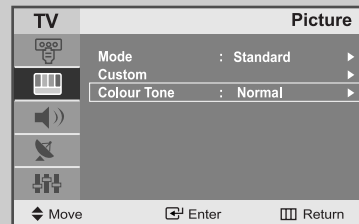
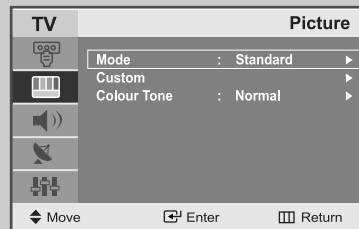

- 5 When you are satisfied with your choice, press the **EXIT** button to return to normal viewing.

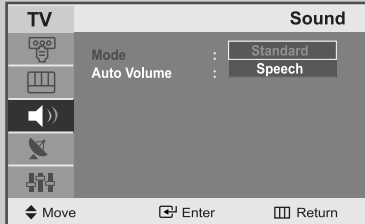
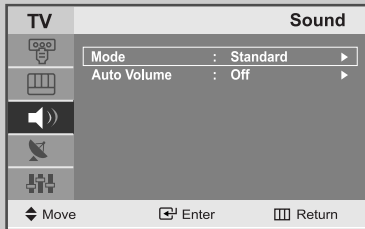

Changing the Sound Standard



You can select the type of special sound effect to be used when watching a given broadcast.

- 1 Press the **MENU** button.
Result: The main menu is displayed.
 - 2 Press the **▲** or **▼** button to select the **Sound**.
Result: The options available in the **Sound** group are displayed.
 - 3 Press the **ENTER**  button.
 - 4 Press the **ENTER**  button.
Result: The **Mode** is selected .
 - 5 Select the required sound effect by pressing the **▲** or **▼** button repeatedly.
Press the **ENTER**  button.
Result: The following sound effects are available:
Standard - Speech
 - 6 Press the **EXIT** button to exit.
- You can also set these options simply by pressing the **S.MODE** (Sound Mode) button.

Selecting Auto Volume Control

Reduces the differences in volume level between broadcasters.

- 1 Press the **MENU** button.

Result: The main menu is displayed.

- 2 Press the **▲** or **▼** button to select the **Sound**.

Result: The options available in the **Sound** group are displayed.

- 3 Press the **ENTER** button.

- 4 Press the **▲** or **▼** button to select **Auto Volume**.

Press the **ENTER** button.

- 5 Press the **▲** or **▼** button to select **Off/On**.

Press the **ENTER** button.

- 6 Press the **EXIT** button to exit.

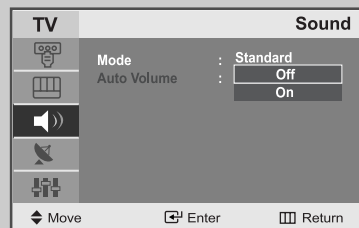
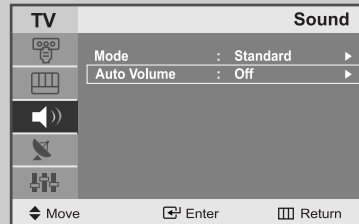
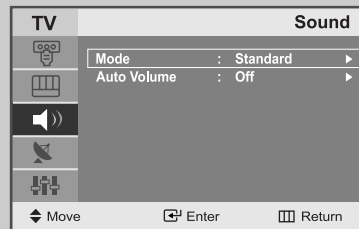

Setting the Clock

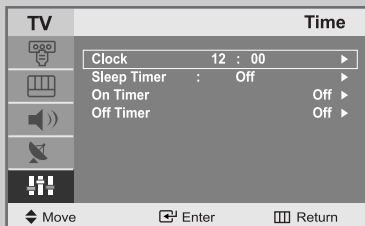
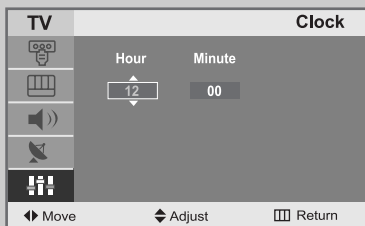
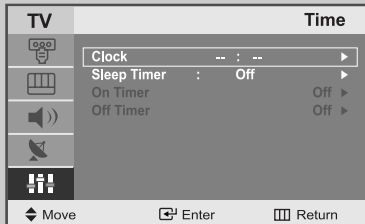

- 1 Press the **MENU** button.
Result: The main menu is displayed.

- 2 Press the **▲** or **▼** button to select **Setup**.
Result: The options available in the **Setup** group are displayed.

- 3 Press the **ENTER** button.
Result: The options available in the **Setup** group are displayed.

- 4 Press the **ENTER** button.
Result: The **Clock** is selected.

- 5 Press the **ENTER** button.
Press the **▲** or **▼** button to set the **Hour**.

- 6 Press the **◀** or **▶** button to move to **Minute**.
Press the **▲** or **▼** button to set the minutes.

- 7 Press the **ENTER** button.
Result: The clock is set.

- 8 Press the **EXIT** button to exit.

➤ You can also set the time using the numeric buttons on the remote.

Switching Off Automatically

You can select a time period of between Off and 180 minutes after which your set automatically switches off.

- 1 Press the **MENU** button.
Result: The main menu is displayed.
- 2 Press the **▲** or **▼** button to select **Setup**.
Result: The options available in the **Setup** group are displayed.
- 3 Press the **ENTER** button.
- 4 Press the **ENTER** button.
Result: The preset **Clock** is selected.
- 5 Press the **▲** or **▼** button to select the **Sleep Timer**.
Press the **ENTER** button.
- 6 Select the number of minutes after which your set switches **On** by pressing the **▲** or **▼** button repeatedly.
Result: The preset time intervals:
Off, 30, 60, 90, 120, 150, 180 minutes.
- 7 Press the **EXIT** button to exit.

- You can also select this feature by simply pressing the "**SLEEP**" button.
If the sleep timer is already set, the screen displays the remaining time and then your set will be switched **Off**.
If the sleep timer is not yet set, **Off** is displayed.
◆ Off • 30 • 60 • 90 • 120 • 150 • 180 • Off

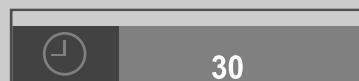
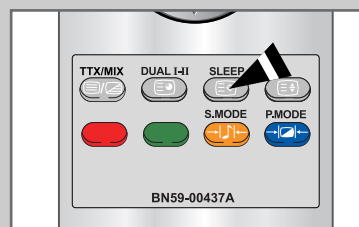
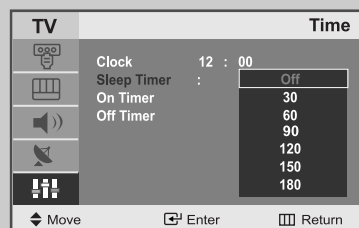
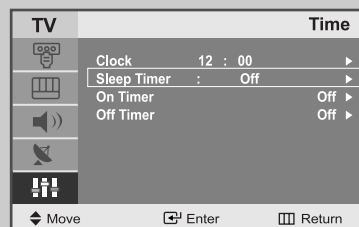
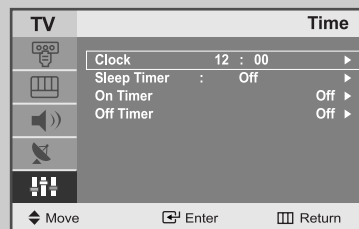

Switching the Television On and Off Automatically

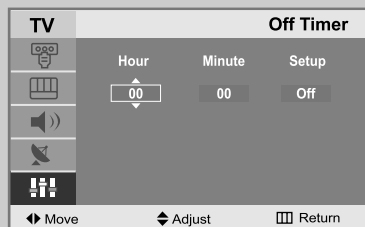
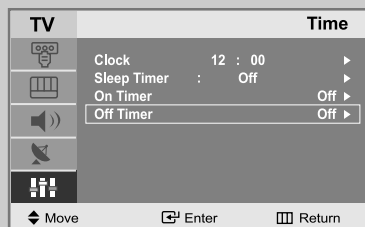
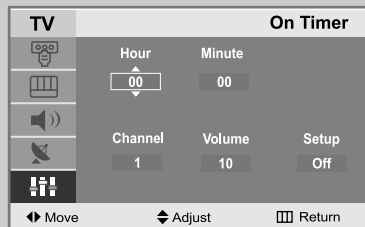
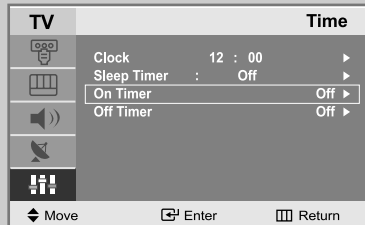
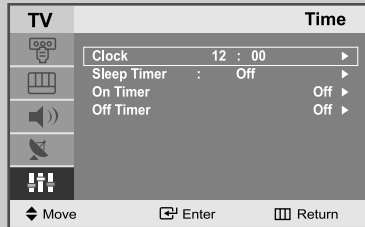

You can set the On/Off timers so that the set will:

- ◆ Switch on automatically and tune to the channel of your choice at the time you select.
- ◆ Switch off automatically at the time you select.

- 1 Press the **MENU** button.
Result: The main menu is displayed.
- 2 Press the **▲** or **▼** button to select **Setup**.
Result: The options available in the **Setup** group are displayed.
- 3 Press the **ENTER** button.
- 4 Press the **ENTER** button.
Result: The **Time** menu are displayed with **Clock** selected.
- 5 Press the **▲** or **▼** button to select the **On Timer**.
Press the **ENTER** button.
Result: The **On Timer** menu is displayed.

To...	Press the...
Move to Hour, Minute, Channel and Volume	◀ or ▶ button
Set Hour, Minute, Channel and Volume level	▲ or ▼ button
Move to Setup	◀ or ▶ button
Select On to enable above setting	▲ or ▼ button

- 6 Press the **MENU** button to return to the previous menu and to set **Off Timer** continuously.
Press the **▲** or **▼** button to select **Off Timer**.

In the same way, set the time at which you wish the set to be switched off automatically.

- 7 Press the **EXIT** button to exit.

Setting the Blue Screen Mode

If no signal is being received or the signal is very weak, a blue screen automatically replaces the noisy picture background.

If you wish to continue viewing the poor picture, you must set the "Blue Screen" mode to "Off".

- 1 Press the **MENU** button.

Result: The main menu is displayed.

- 2 Press the **▲** or **▼** button to select **Setup**.

Result: The options available in the **Setup** group are displayed.

- 3 Press the **ENTER**  button.

- 4 Press the **▲** or **▼** button to select **Blue Screen**.
Press the **ENTER**  button.

- 5 Select the required option (**On** or **Off**) by pressing the **▲** or **▼** button.

- 6 Press the **EXIT** button to return to normal viewing.

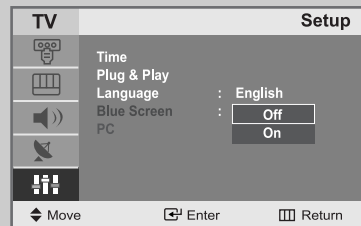
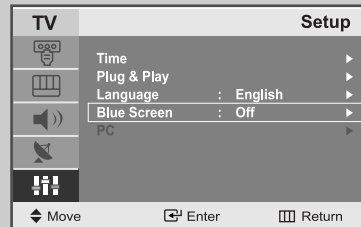
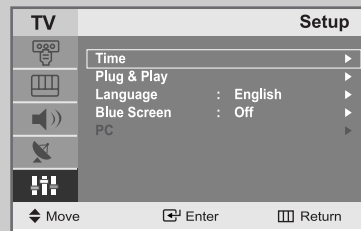

Displaying Information

You can view the setting status of the selected source by pressing the "INFO" button on the remote control.

The information displayed varies according to the selected source.

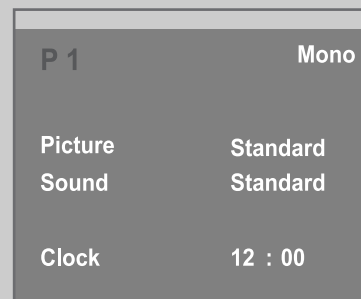

Teletext Feature

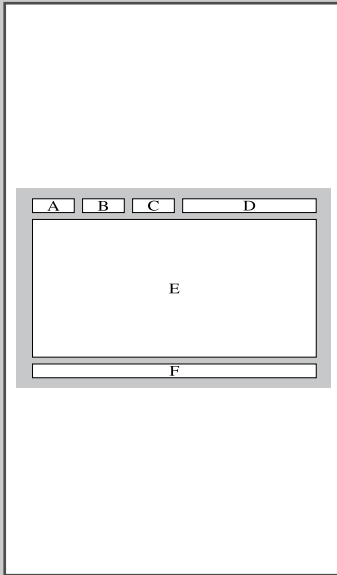

Most television channels provide written information services via teletext.

Information provided includes:

- ◆ *Television programme times*
- ◆ *News bulletins and weather forecasts*
- ◆ *Sports results*
- ◆ *Travel information*

This information is divided into numbered pages (see diagram).

Part	Contents
A	Selected page number.
B	Broadcasting channel identity.
C	Current page number or search indicators.
D	Date and time.
E	Text.
F	Status information. FASTEXT information.

➤ Teletext information is often divided between several pages displayed in sequence, which can be accessed by:

- ◆ Entering the page number
- ◆ Selecting a title in a list
- ◆ Selecting a coloured heading (FASTEXT system)

Displaying the Teletext Information

You can display Teletext information at any time on your set.

☞ For Teletext information to be displayed correctly, channel reception must be stable; otherwise:

- ◆ Information may be missing
- ◆ Some pages may not be displayed

- 1 Select the channel providing the Teletext service using the **▲** or **▼** button.
- 2 Press the **TTX/MIX** button to activate the teletext mode.
Result: The contents page is displayed. It can be redisplayed at any time by pressing the **INDEX** button.
- 3 If you wish to display the actual broadcast at the same time as the teletext page, press the **TTX/MIX** button again.
- 4 Press the **TV**(□) button again to exit the teletext display.

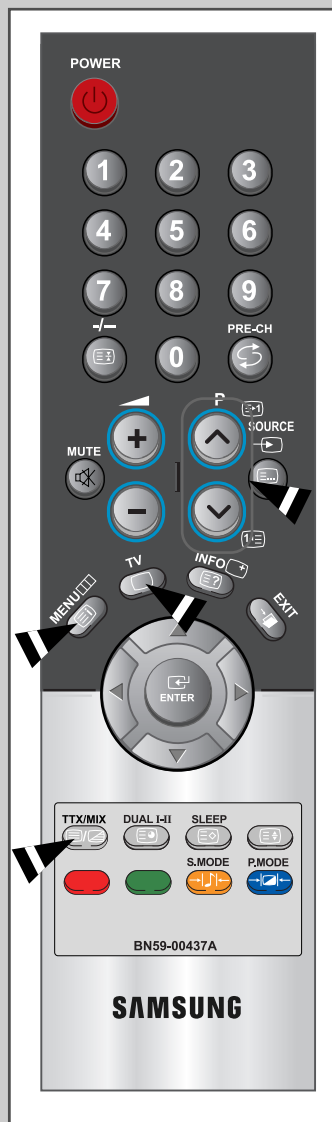

Selecting a Page by Number



You can enter the page number directly by pressing the numeric buttons on the remote control.



- 1 Enter the three-digit page number given in the content by pressing the corresponding numeric buttons.
Result: The current page counter is incremented and the page is then displayed.
- 2 If the selected page is linked with several secondary pages, the secondary pages are displayed in sequence.
To freeze the display on a given page, press the (hold) button. Press the (hold) button again to resume.

Using the various display options:

To display...	Press the...
◆ Hidden text (answers to quiz games, for example)	(reveal)
◆ The normal screen	(reveal) again
◆ A secondary page, by entering its 4-digit number	(subpage)
◆ The next page	(page up)
◆ The previous page	(page down)
◆ Double-size letters in the: <ul style="list-style-type: none"> • Upper half of the screen • Lower half of the screen 	(size) <ul style="list-style-type: none"> • Once • Twice
◆ Normal screen	• Three times

Using FLOF to Select a Page



The various topics included in the teletext pages are colour-coded, and can be selected by pressing the coloured buttons on the remote control.

- 1 Display the teletext contents page by pressing the **TTX/MIX** button.
- 2 Press the coloured button corresponding to the topic that you wish to select; the available topics are given on the status line.
Result: The page is displayed with other coloured information that can be selected in the same way.
- 3 To display the previous or next page, press the corresponding coloured button.
- 4 To display the subpage, see the following steps.
 - ◆ Press the  (subpage) button.
 - Result:** The available subpages appear.
 - ◆ Select the required subpage.
Subpages can be scrolled by using the  or  button.



Storing Teletext Pages

You can store up to four teletext pages to display them later at leisure.

- 1 Select the LIST mode using the  (LIST/FLOF) button.
Result: Four 3-digit numbers are displayed in different colours.
 - The  (LIST/FLOF) button is used to switch between the LIST and FLOF modes.
- 2 Press the coloured button corresponding to the page that will be replaced.
- 3 Enter the new page number using the numeric buttons.
- 4 Repeat steps 2 and 3 for each page to be stored, using a different coloured button each time.
- 5 Press the  (store) button until the corresponding blocks blink.



Setting Up Your PC Software (Based on Windows XP)



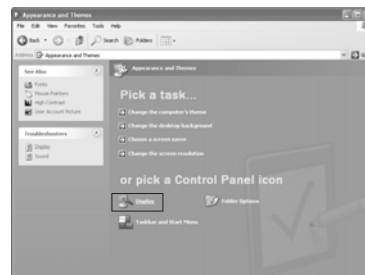
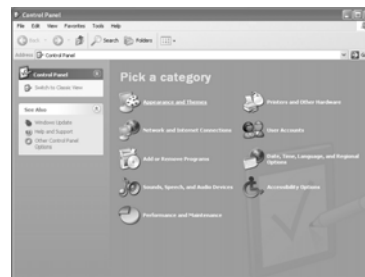

The Windows display-settings for a typical computer are shown below. The actual screens on your PC will probably be different, depending upon your particular version of Windows and your particular video card. However, even if your actual screens look different, the same basic set-up information will apply in almost all cases. (If not, contact your computer manufacturer or Samsung Dealer.)

- 1 First, click on “**Control Panel**” on the Windows start menu.
- 2 When the control panel window appears, click on “**Appearance and Themes**” and a display dialog-box will appear.
- 3 When the control panel window appears, click on “**Display**” and a display dialog-box will appear.
- 4 Navigate to the “**Settings**” tab on the display dialog-box.
The correct size setting (resolution)
 - 15” 1024 x 768 pixels
 - 17” 1280 x 1024 pixels
 - 20” 640 x 480 pixels
 If a vertical-frequency option exists on your display settings dialog box, the correct value is “60” or “60 Hz”. Otherwise, just click “**OK**” and exit the dialog box.



Coarse and Fine Tuning of the Image

➤ Preset to PC mode by pressing the **SOURCE** button on the remote control .

- 1 Press the **MENU** button.
Result: The main menu is displayed.
- 2 Press the **▲** or **▼** button to select **Setup**.
Result: The options available in the **Setup** group are displayed.
- 3 Press the **ENTER**  button.
- 4 Press the **▲** or **▼** button to select **PC**.
Press the **ENTER**  button.
Result: The options available in the **PC** menu are displayed.
- 5 Press the **ENTER**  button.
Result: The **Image Lock** menu is selected.
- 6 Press the **▲** or **▼** button to select **Coarse** or **Fine**.
Press the **ENTER**  button.
Result: The horizontal bar is displayed.
- 7 Press the **◀** or **▶** button to adjust the screen quality.
Vertical stripes may appear or the picture may become blurry.
- 8 When you are satisfied with the settings, press the **MENU** button to return to the previous menu or press the **EXIT** button to return to normal viewing.

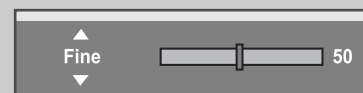
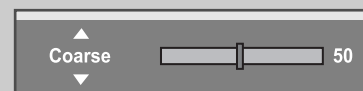
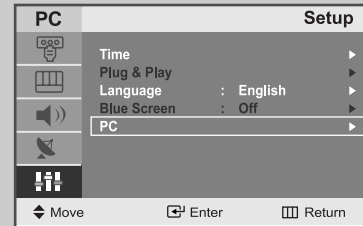
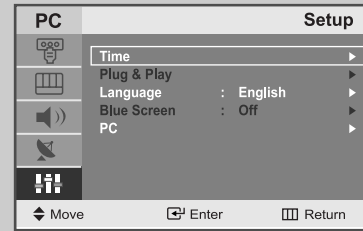

Changing the Image Position

➤ Preset to PC mode by pressing the **SOURCE** button on the remote control.

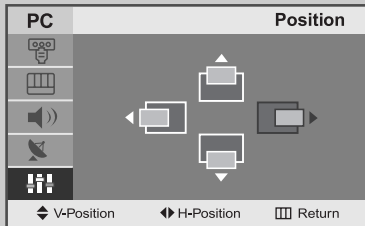
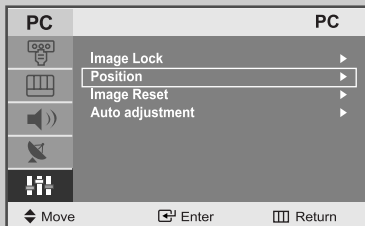
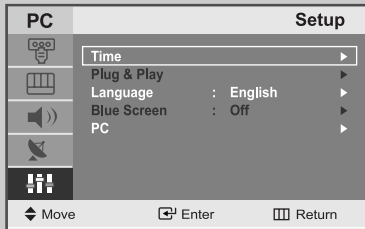

1 Press the **MENU** button.

Result: The main menu is displayed.

2 Press the **▲** or **▼** button to select **Setup**.

Result: The options available in the **Setup** group are displayed.

3 Press the **ENTER** button.

4 Press the **▲** or **▼** button to select **PC**.
Press **ENTER** button.

Result: The options available in the **PC** menu are displayed.

5 Press the **▲** or **▼** button to select **Position**.
Press the **ENTER** button.

Result: You can adjust the image **Position**.

6 Press the **▲** or **▼** button to adjust the vertical position.
Press the **◀** or **▶** button to adjust the horizontal position.

7 Press the **MENU** button to return to the previous menu or
press the **EXIT** button to return to normal viewing.

Initializing the Image Settings

➤ Preset to PC mode by pressing the **SOURCE** button on the remote control.

You can replace all image settings with the factory default values.

- 1 Press the **MENU** button.
Result: The main menu is displayed.
- 2 Press the **▲** or **▼** button to select **Setup**.
Result: The options available in the **Setup** group are displayed.
- 3 Press the **ENTER** button.
Result: The options available in the **PC** menu are displayed.
- 4 Press the **▲** or **▼** button to select **PC**.
Press **ENTER** button.
Result: The options available in the **PC** menu are displayed.
- 5 Press the **▲** or **▼** button to select **Image Reset**.
Press the **ENTER** button.
Result: The message "Image Reset has completed." is displayed.
- 6 Press the **MENU** button to return to the previous menu or press the **EXIT** button to return to normal viewing.

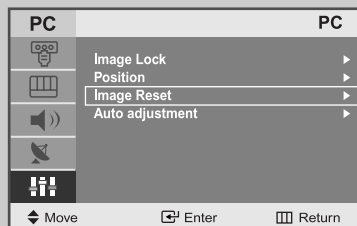
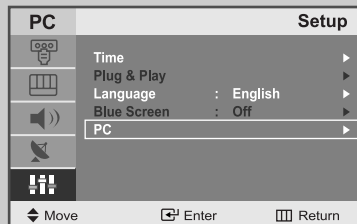
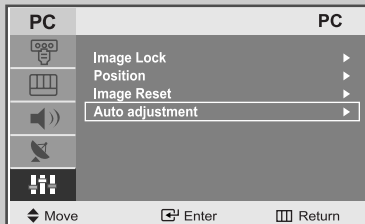
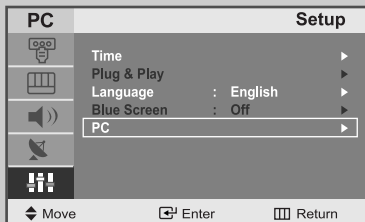

Image Reset has completed.

Adjusting the PC Screen Automatically





Auto adjustment

➤ Preset to PC mode by pressing the **SOURCE** button on the remote control.

- 1 Press the **MENU** button.
Result: The main menu is displayed.

- 2 Press the **▲** or **▼** button to select **Setup**.
Result: The options available in the **Setup** group are displayed.

- 3 Press the **ENTER**  button.



- 4 Press the **▲** or **▼** button to select **PC**.
Press **ENTER**  button.
Result: The options available in the **PC** menu are displayed.

- 5 Press the **▲** or **▼** button to select **Auto adjustment**.
Press the **ENTER**  button.
Result: The screen quality and position are automatically adjusted, and the screen returns to the original view a few seconds later.

- 6 Press the **MENU** button to return to the previous menu or press the **EXIT** button to return to normal viewing.

Picture Mode

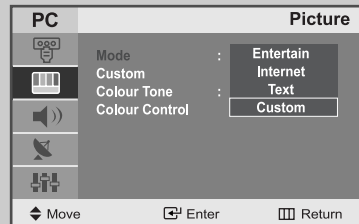
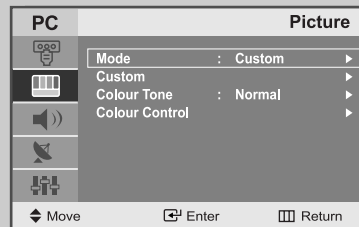

You can select the type of picture which best corresponds to your viewing requirements.

- 1 Press the **MENU** button.
Result: The main menu is displayed.
- 2 Press the **▲** or **▼** button to select the **Picture**.
Result: The options available in the **Picture** group are displayed.
- 3 Press the **ENTER**  button.
- 4 Press the **ENTER**  button.
Result: The **Mode** is selected.
- 5 Select the required picture effect by pressing the **▲** or **▼** button repeatedly. Press the **ENTER**  button.
Result: The following picture effects are available:
Entertain - Internet - Text - Custom
- 6 Press the **EXIT** button to exit.



Adjusting the Custom Picture

Your set has several settings which allow you to control picture quality.

- 1 Press the **MENU** button.
Result: The main menu is displayed.
- 2 Press the **▲** or **▼** button to select the **Picture**.
Result: The options available in the **Picture** group are displayed.
- 3 Press the **ENTER**  button.
- 4 Press the **▲** or **▼** button to select the **Custom**. Press the **ENTER**  button.
- 5 Select the option (**Contrast**, **Brightness**) to be adjusted by pressing the **▲** or **▼** button. Press the **ENTER**  button.
Result: The horizontal bar is displayed.
- 6 Press the **◀** or **▶** button to reach the required setting.
- 7 When you are satisfied with the setting, press the **MENU** button to return to the previous menu or press the **EXIT** button to return to normal viewing.

➤ If you make any changes to these settings, the picture standard is automatically switched to **Custom**.

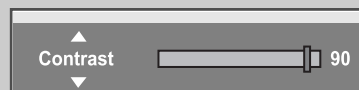
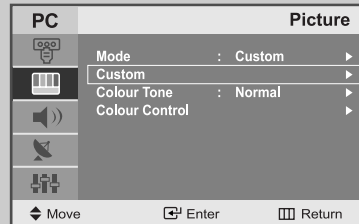
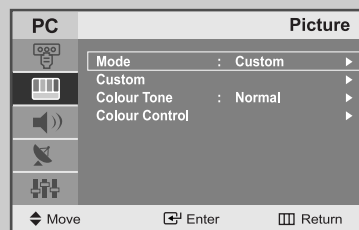

Adjusting the Screen Background Colour

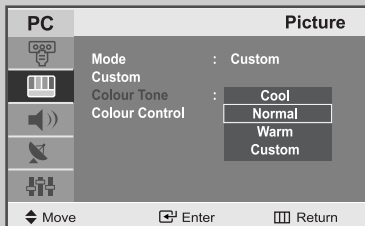
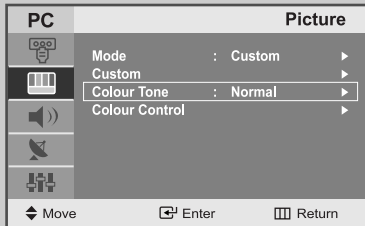
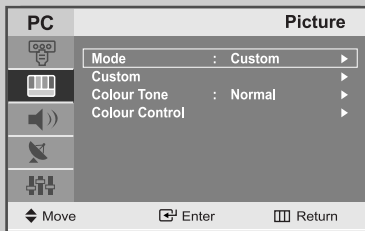

You can change the screen background colour according to your preference.

- 1 Press the **MENU** button.
Result: The main menu is displayed.



- 2 Press the **▲** or **▼** button to select the **Picture**.
Result: The options available in the **Picture** group are displayed.

- 3 Press the **ENTER**  button.

- 4 Press the **▲** or **▼** button to select the **Colour Tone**.
Press the **ENTER**  button.
Result: The following options are available:
Cool - Normal - Warm - Custom

- 5 When you are satisfied with your choice, press the **EXIT** button to return to normal viewing.

Customizing the Colour

- 1 Press the **MENU** button.
Result: The main menu is displayed.
- 2 Press the **▲** or **▼** button to select the **Picture**.
Result: The options available in the **Picture** group are displayed.
- 3 Press the **ENTER**  button.
- 4 Press the **▲** or **▼** button to select the **Colour Control**.
Press the **ENTER**  button.
- 5 Select the option (**Red, Green, Blue**) to be adjusted by pressing the **▲** or **▼** button.
Press the **ENTER**  button.
Result: The horizontal bar is displayed.
- 6 Press the **◀** or **▶** button to reach the required setting.
- 7 When you are satisfied with the setting, press the **MENU** button to return to the previous menu or press the **EXIT** button to return to normal viewing.

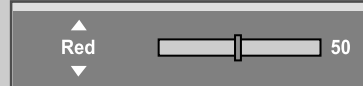
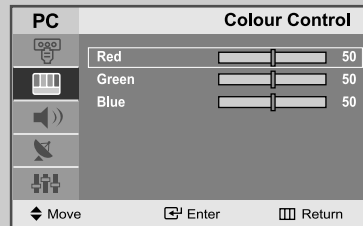
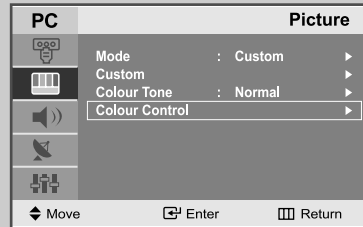
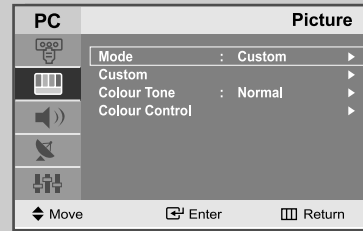

Troubleshooting: Before Contacting Service Personnel

Before contacting Samsung after-sales service, perform the following simple checks.

If you cannot solve the problem using the instructions below, note the model and serial number of your set and contact your local dealer.

No sound or picture.	<ul style="list-style-type: none"> ◆ Check that the mains lead has been connected to a wall socket. ◆ Check that you have pressed the POWER button. ◆ Check the picture contrast and brightness settings. ◆ Check the volume.
Normal picture but no sound.	<ul style="list-style-type: none"> ◆ Check the volume. ◆ Check whether the MUTE button has been pressed on the remote control.
No picture or black and white picture.	<ul style="list-style-type: none"> ◆ Adjust the colour settings. ◆ Check that the broadcast system selected is correct.
Sound and picture interference.	<ul style="list-style-type: none"> ◆ Try to identify the electrical appliance that is affecting the set and move it further away. ◆ Plug your set into a different mains socket.
Blurred or snowy picture, distorted sound.	<ul style="list-style-type: none"> ◆ Check the direction, location and connections of your aerial. This interference is often due to the use of an indoor aerial.
Remote control malfunctions.	<ul style="list-style-type: none"> ◆ Replace the remote control batteries. ◆ Clean the upper edge of the remote control (transmission window). ◆ Check the battery terminals.
"Check Signal Cable" message is displayed.	<ul style="list-style-type: none"> ◆ Check that the signal cable is firmly connected to the PC. ◆ Check that the PC is turned on.
In PC mode, "Not Supported Mode" message is displayed.	<ul style="list-style-type: none"> ◆ Check the maximum resolution and the frequency of the video adapter. ◆ Compare these values with the data in the Display Modes Timing Chart (refer to page 49).
In PC mode, horizontal or vertical bars appear to flicker, jitter or shimmer on the image.	<ul style="list-style-type: none"> ◆ Adjust the Coarse or Fine function.
In PC mode, the screen is black and the power indicator light is steady amber or blinks every 0.5 or 1 seconds.	<ul style="list-style-type: none"> ◆ The TV is using its power management system. ◆ Move the computer's mouse or press a key on the keyboard.

Troubleshooting: Before Contacting Service Personnel

In PC mode, the image is not stable and may appear to vibrate.

- ◆ Check that the display resolution and frequency from your computer or video board is an available mode for your set. On your computer check: Control Panel, Display, Settings.
- ◆ If the setting is not correct, use your computer utility programme to change the display settings.

➤ Your set supports multiscan display functions within the following frequency domain:

	15"(LM15M23C)	17"(LM17M24C)	20"(LM20M21C)	20"(LM20M22C)
Horizontal frequency(kHz)	30-69	30-80	28-33	28-33
Vertical frequency(Hz)	50-75	50-75	50-70	50-75
Maximum refresh rate (at 75Hz)	1024X768	1280X1024	640X480	800X600

In PC mode, the image is not centred on the screen.

- ◆ Adjust the horizontal and vertical position.

Power Saver

This set has a built-in power management system called PowerSaver. This system saves energy by switching your set into a low-power mode when it has not been used for a certain period of time. The available modes are "On", "Standby", "Sleep", and "Deep Sleep". PowerSaver operates with a VESA DPMS compliant video card installed in your computer. You use a software utility installed on your computer to set up this feature.

State	Normal Operation	Power-Saving Function mode (EPA/NUTEK)
Horizontal Sync	Active	Inactive
Vertical Sync	Active	Inactive
Power Indicator	Off	Red, Blinking (1 sec interval)
Power Consumption	15" 40W, 17" 45W, 20" 55W	Less than 3W

- ***This set automatically returns to normal operation when horizontal and vertical sync are restored. This occurs when you move the computer's mouse or press a key on the keyboard.***

Technical and Environmental Specifications

Model Name	LW15M23C	LW17M24C	LW20M21C	LW20M22C
Panel Size Display Size Type Pixel Pitch Viewing Angle	331.6(H) x 254.9(V)mm 304.1(H) x 228.1(V)mm a-si TFT active matrix 0.297(H) x 0.297(V)mm 140/115	383.5(H) x 298.0(V)mm 337.9(H) x 270.3(V)mm a-si TFT active matrix 0.264(H) x 0.264(V)mm 140/120	413.0(H) x 311.0(V)mm 408.0(H) x 306.0(V)mm a-si TFT active matrix 0.6375(H) x 0.6375(V)mm 160/150	413.0(H) x 311.0(V)mm 408.0(H) x 306.0(V)mm a-si TFT active matrix 0.51(H) x 0.51(V)mm 160/120
Frequency Horizontal Vertical Display Color	30 ~ 69kHz 50 ~ 75Hz 16.2 Million	30 ~ 80 kHz 50 ~ 75Hz 16.2 Million	28 ~ 33kHz 50 ~ 70Hz 16.7 Million	28 ~ 33kHz 50 ~ 75Hz 16.7 Million
Resolution Optimum Maximum	1024 x 768@60Hz 1024 x 768@75Hz	1280 x 1024@60Hz 1280 x 1024@75Hz	640 x 480@60Hz 640 x 480@70Hz	800 x 600@60Hz 800 x 600@75Hz
Input Signal Sync. Video Signal	H/V Separate, TTL, P or N 0.7 Vp-p @75 Ω			
Video Color System Video System	PAL / NTSC / SECAM CVBS, S-VHS, RGB			
Power Supply Input Output	AC 100V ~ 240V (50 / 60Hz)			
Power Consumption Maximum Power Saving	40W <3W	45W <3W	55W <3W	55W <3W
Dimension (W x D x H) TV Body With stand	360.2 x 64.2 x 338.6 mm (14.18 x 2.53 x 13.33 inch) 360.2 x 192.9 x 396.5 mm (14.18 x 7.59 x 15.61 inch)	416.7x 71.8 x 392.9 mm (16.40 x 2.82 x 15.46 inch) 416.7 x 192.9 x 423.8 mm (16.40 x 7.59 x 16.68 inch)	479.0 x 74.7 x 436.4 mm (18.86 x 2.94 x 17.18 inch) 479.0 x 226.0 x 463.0 mm (18.86 x 8.90 x 18.23 inch)	479.0 x 74.7 x 436.4 mm (18.86 x 2.94 x 17.18 inch) 479.0 x 226.0 x 463.0 mm (18.86 x 8.90 x 18.23 inch)
Weight With stand	3.6 kg (7.94 lbs)	4.95 kg (10.91 lbs)	7.15 kg (15.76 lbs)	7.45 kg (16.42 lbs)
Environmental Considerations Operationg Temperature Operating Humidity Storage Temperature Storage Humidity	50°F to 104°F (10°C to 40°C) 10% to 80%, non-condensing -4°F to 113°F (-20°C to 45°C) 5% to 95%, non-condensing			
Audio Characteristics Audio Input PC Audio Input Audio Output Headphone Output Frequency Response	RCA Jack Red®, White(L), 0.5Vrms(-9dB) 3.5∅ Stereo Jack, 0.5Vrms(-9dB) 2.5W x 2 Max.10mW Output(3.5∅ Stereo Jack 32) RF : 80Hz ~15kHz at -3dB A/V : 80Hz ~20kHz at -3dB			

Display Modes

If the signal from the system equals the standard signal mode, the screen is adjusted automatically. If the signal from the system doesn't equal the standard signal mode, adjust the mode by referring to your Videocard user guide; otherwise there may be no video. For the display modes listed below, the screen image has been optimized during manufacture.

Mode(PC)		Resolution	Horizontal Frequency (kHz)	Vertical Frequency (Hz)	Pixel Clock Frequency (MHz)	Sync Polarity (H/V)
VGA	LW 15M23C 17M24C 20M21C 20M22C	720X400	31.469	70.087	28.322	- / +
		640X480	31.469	59.940	25.175	- / -
	LW 15M23C 17M24C 20M22C	640X480	37.500	75.000	31.500	- / -
SVGA LW15M23C, 17M24C, 20M22C		800X600	46.875	75.000	49.500	+ / +
		800X600	37.879	60.317	40.000	+ / +
XGA LW15M23C, 17M24C		1024X768	48.363	60.004	65.000	- / -
		1024X768	60.023	75.029	78.750	+ / +
SXGA LW17M24C		1280X1024	63.981	60.020	108.000	+, - / -, +
		1280X1024	79.976	75.025	135.000	+ / +

Cleaning and Maintaining Your TV

Please follow these guidelines to get the maximum performance from your TV.

Placement

- Do not place the TV near extremely hot, cold, humid or dusty places.
- Do not place the TV near appliances with electric motors that create magnetic fields, such as vacuum cleaners.
- Keep the ventilation openings clear; do not place the TV on a soft surface, such as cloth or paper.
- Place the TV in a vertical position only.

Liquids

- Do not handle liquids near or on the TV.
Liquids that spill into it can cause serious damage.

Cabinet

- Never open the cabinet or touch the parts inside.
- Wipe your TV with a clean, dry cloth. Never use water, cleaning fluids, wax, or chemicals.
- Do not put heavy objects on top of the cabinet.

Temperature

- If your TV is suddenly moved from a cold to a warm place, unplug the power cord, and allow at least two hours for moisture that may have formed inside the unit to dry completely.

Using Your TV in Another Country

If you plan to take your TV with you to a foreign country, please be aware of the different television systems that are in use around the world.

A TV designed for one system may not work properly with another system due to differences in the TV channel frequencies.

Using the Anti-Theft Kensington Lock

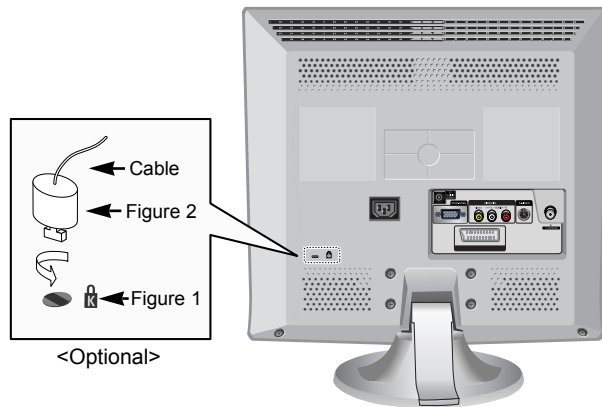

The Kensington lock is a device used to physically fix the system when using it in a public place. The locking device has to be purchased separately. The appearance and locking method may differ from the illustration depending on the manufacturer. Please refer to the manual provided with the Kensington lock for proper use.

1. Insert the locking device into the Kensington slot on the LCD TV (Figure 1), and turn it in the locking direction (Figure 2).
2. Connect the Kensington lock cable.
3. Fix the Kensington lock to a desk or a heavy stationary object.

Installing the Wall Mount Kit

This installation is to be used when attaching the wall mount to a concrete wall. When attaching to other building materials, please contact your nearest dealer.

1 Secure the bracket to the wall.

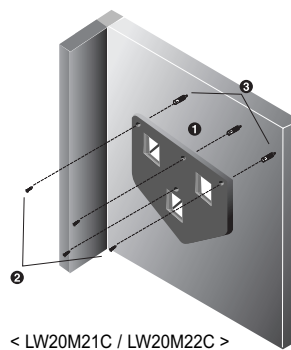
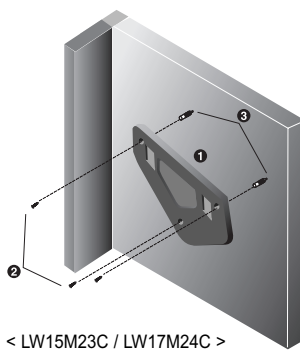

2 Fold the stand in the direction of the arrow. **3** Mount the TV on the wall mount bracket.

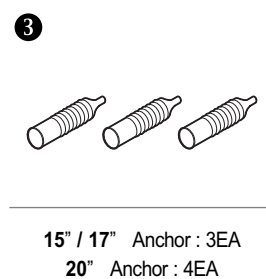
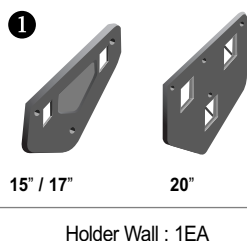
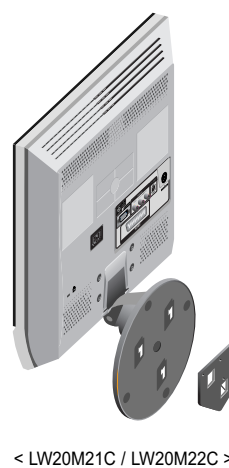
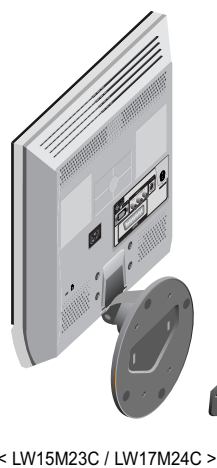
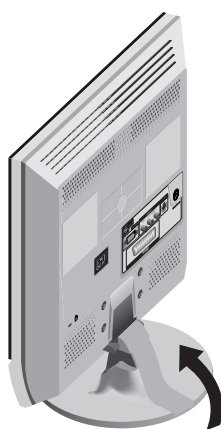

Installing VESA compliant mounting devices

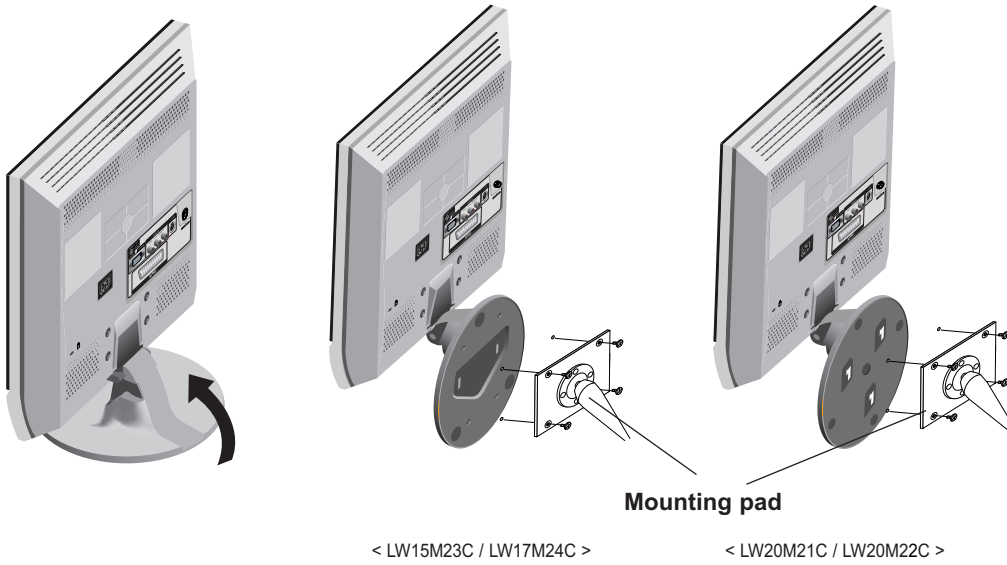

Align the mounting interface pad with the holes in the rear cover mounting pad and secure it with the four screws that come with the arm-type base, wall mount hanger or other bases.

Memo



- AFTER SALES SERVICE

- Do not hesitate to contact your retailer or service agent if a change in the performance of your product indicates that a faulty condition may be present.

